

ZCORD Number

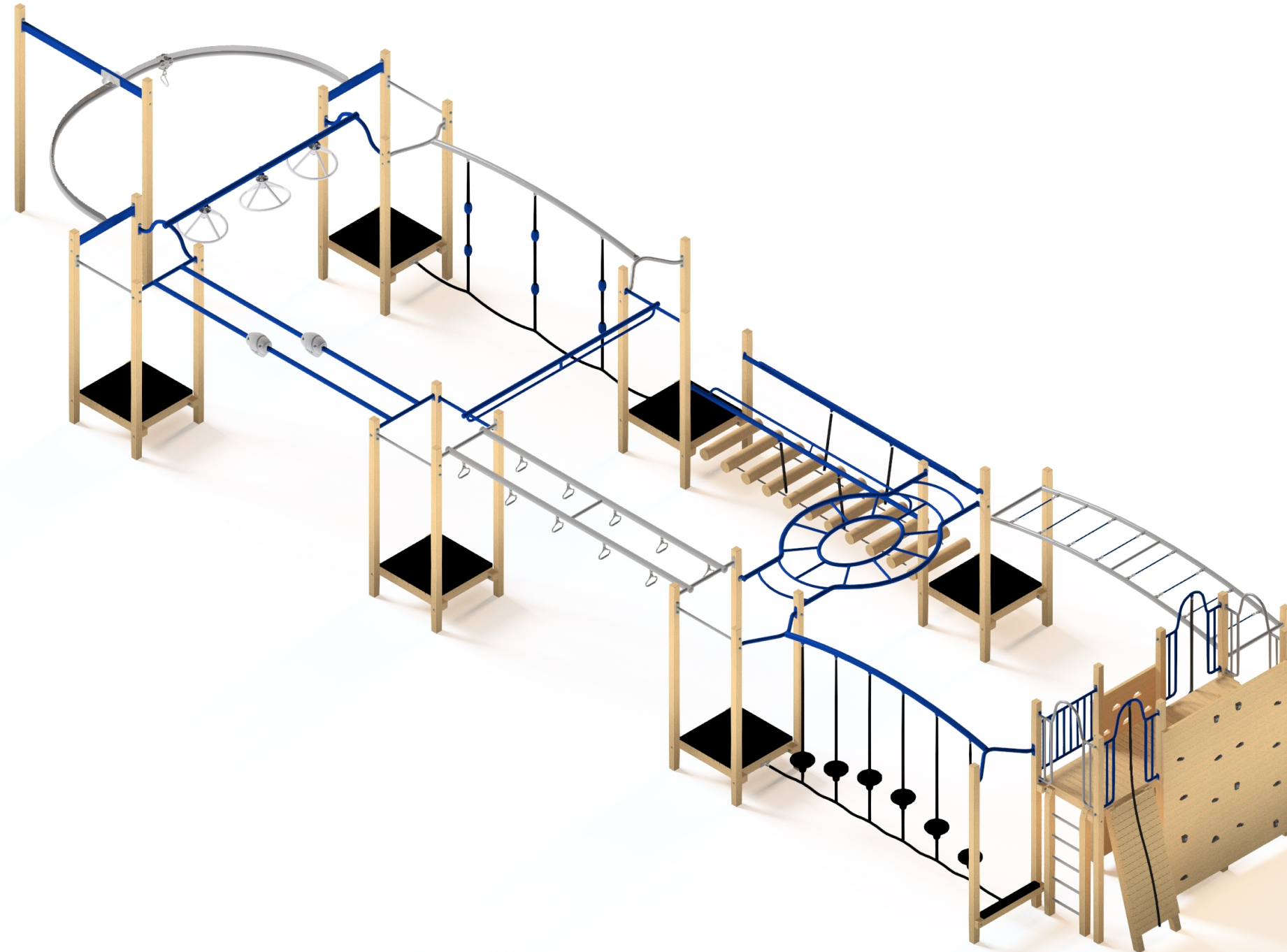

ZCORD Number

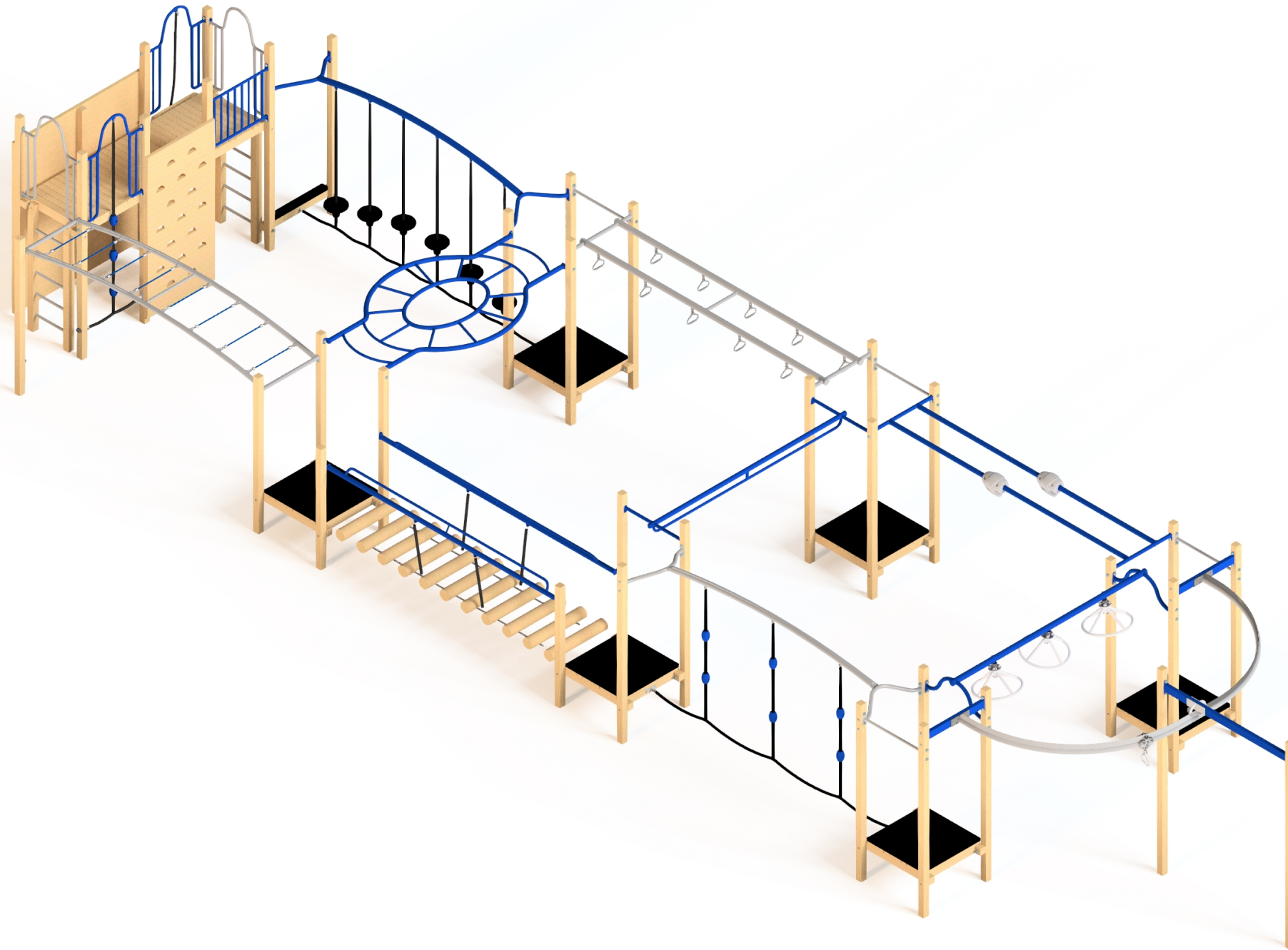

ZCORD Number

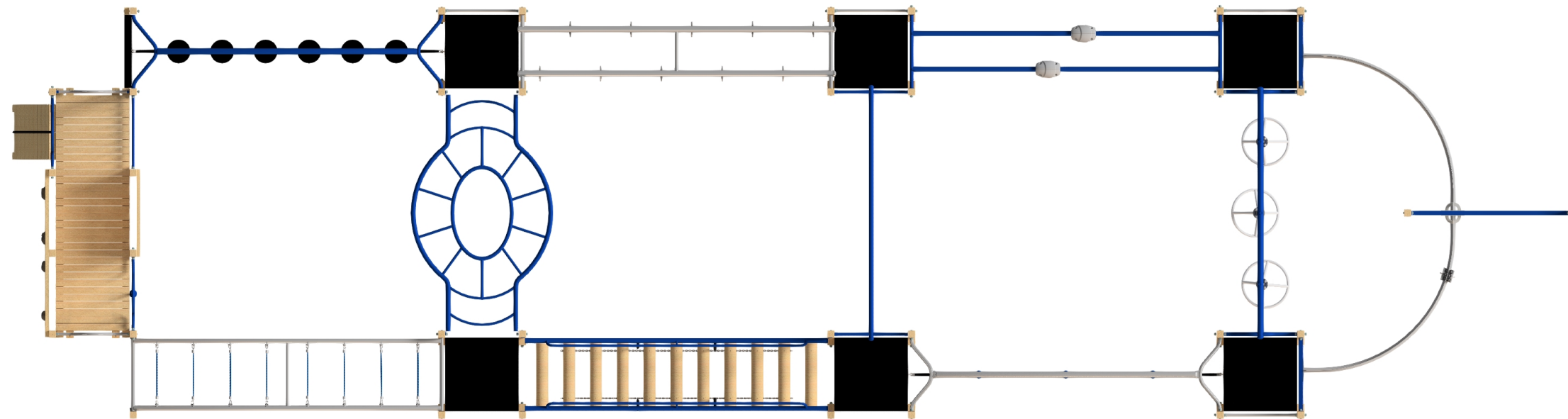

ZCORD Number  
1:100 @ A3

Fallzone

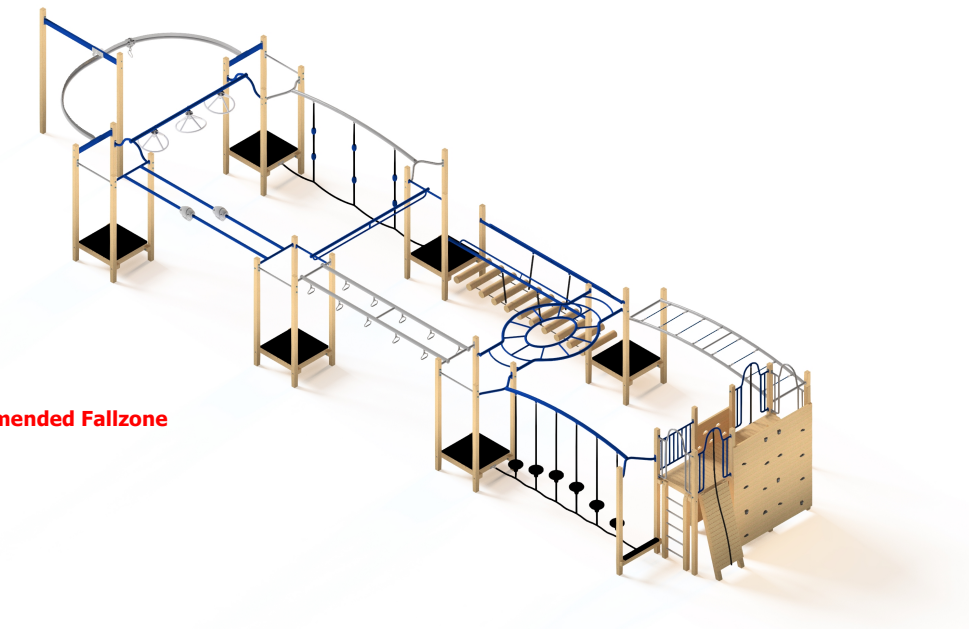
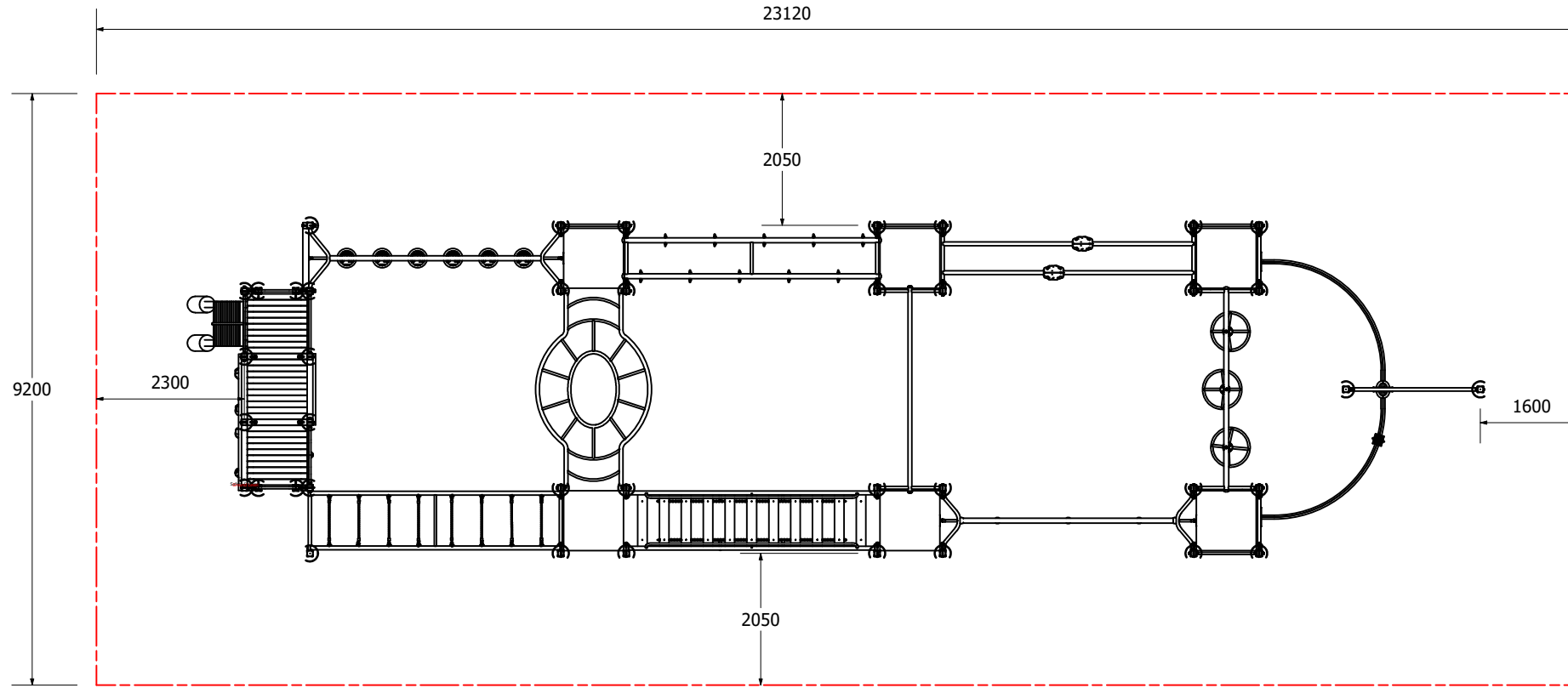

Recommended Fallzone

Right Elevation

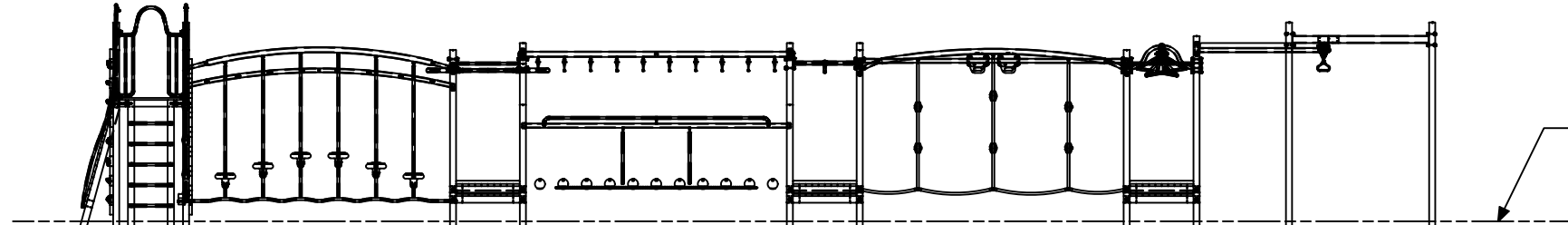

Top of Safety Surface

Front Elevation

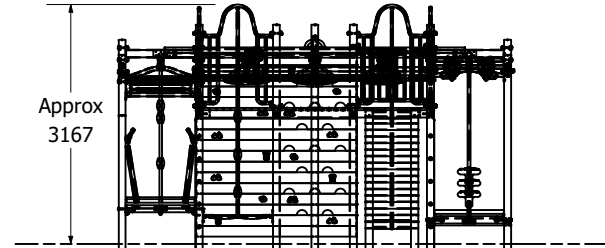

Technical Information	
Main Dimension	23120 x 9200
Total Area	213m2
Max FHO	2500
Heaviest Part	--
Compliant to	NZS 5828:2015 AS 4685:2017 EN 1176:2008

REVISION HISTORY			
REV	DESCRIPTION	DATE	BY
0	Creation	12/11/2020	Sam