

# Xtreme Fitness 555 - Stage 3 (Complete Unit)

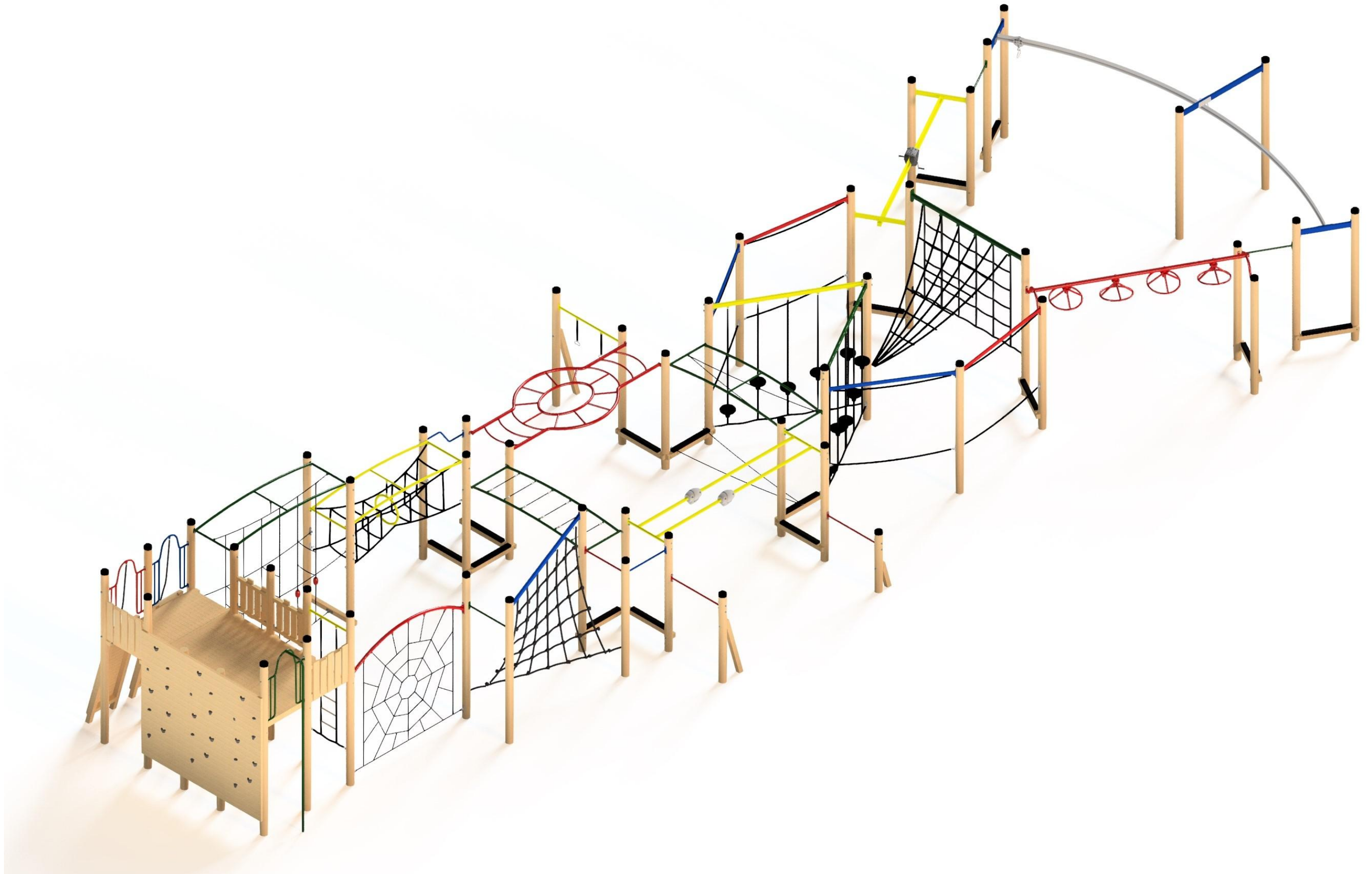

# Xtreme Fitness 555 - Stage 3 (Complete Unit)

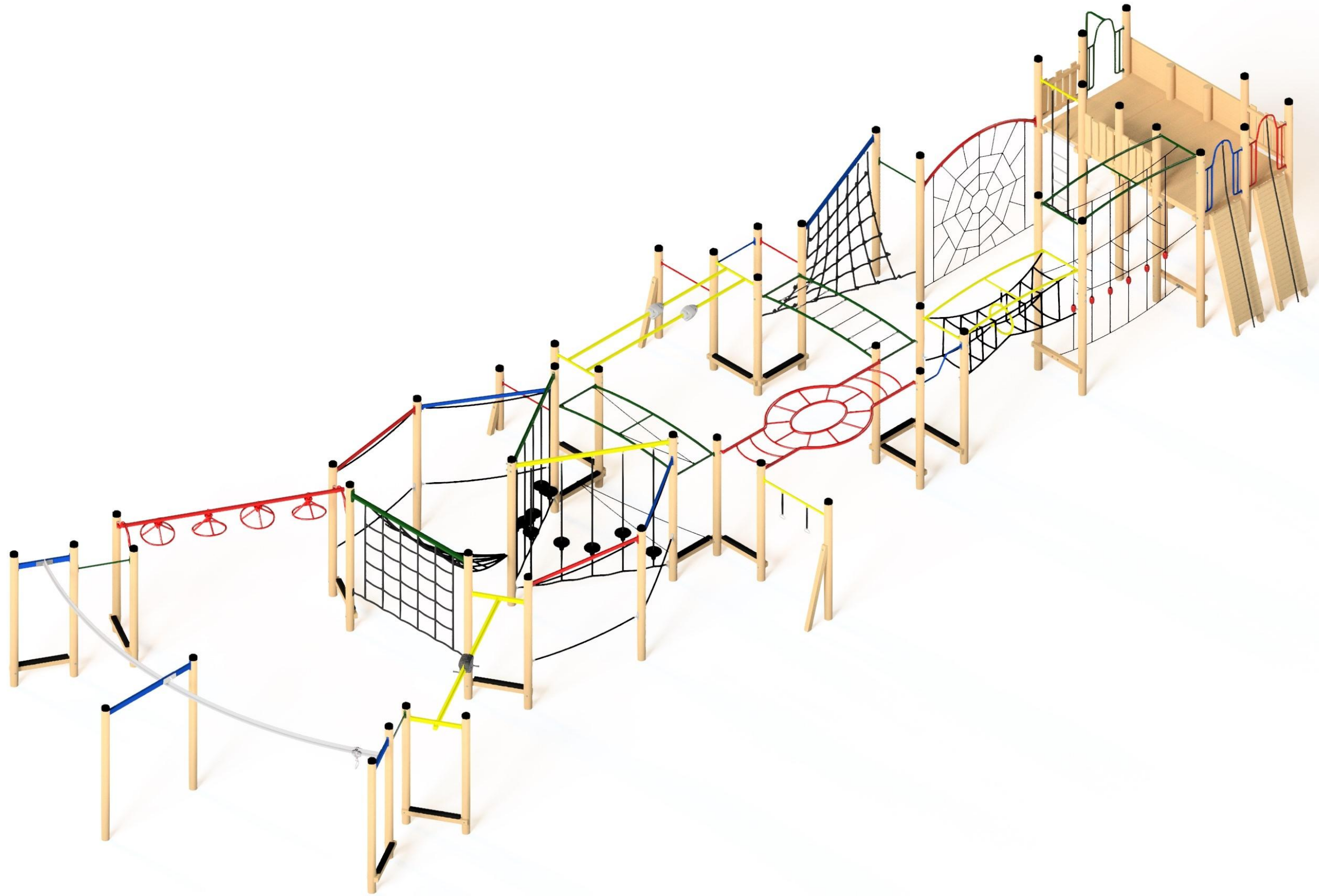



# Xtreme Fitness 555 - Stage 3 (Complete Unit)

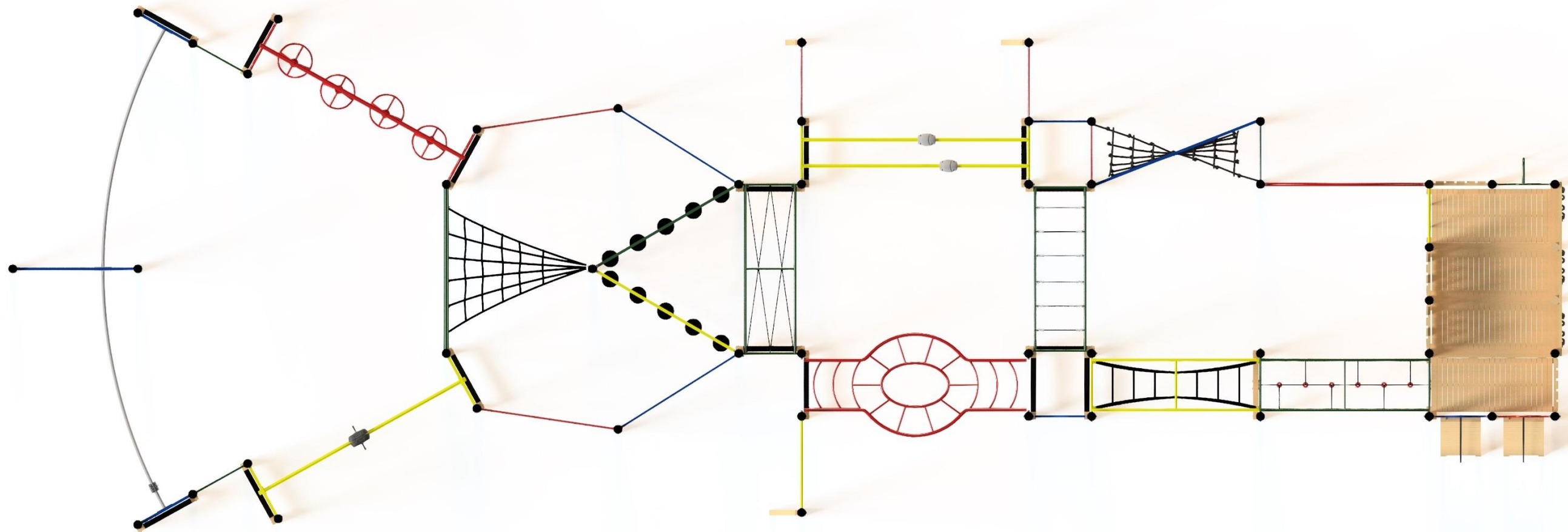

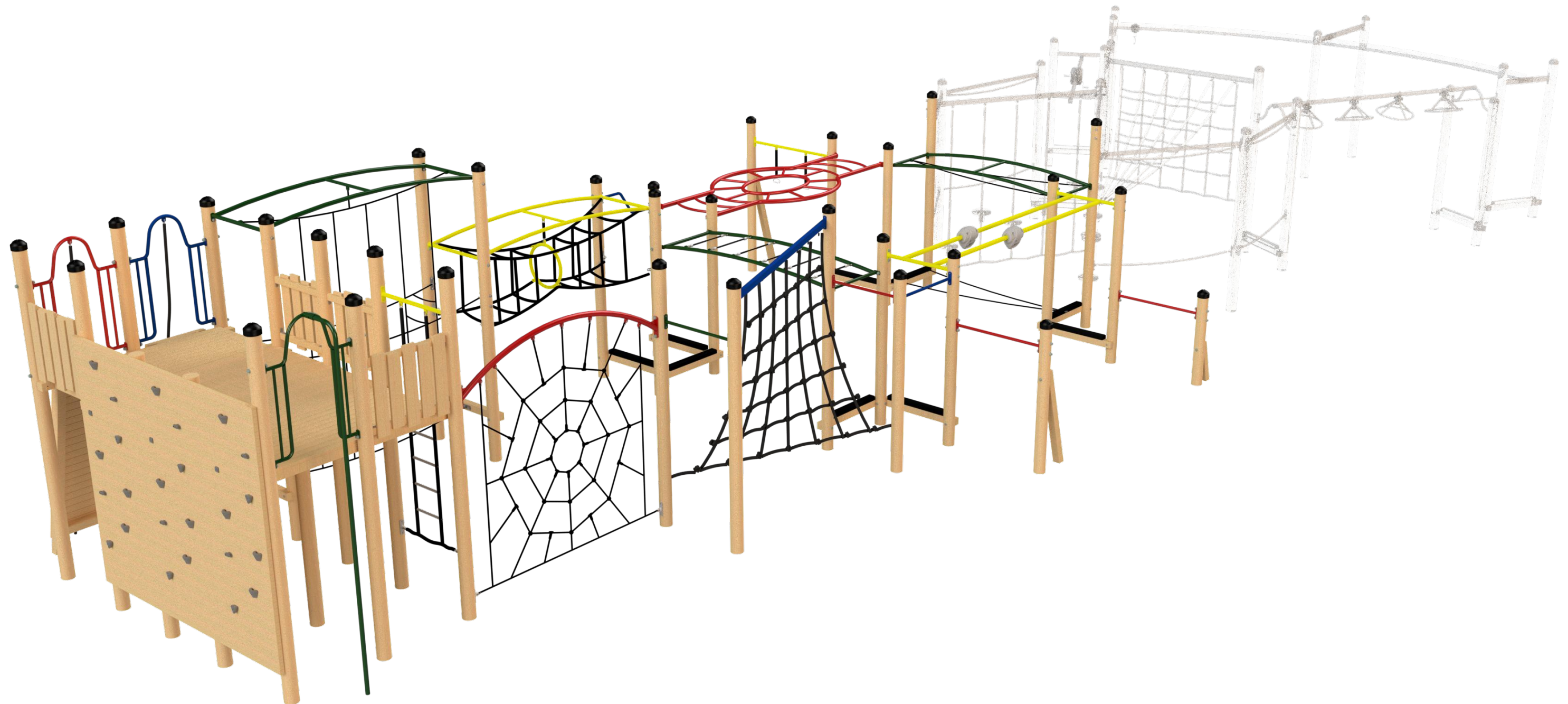

# Xtreme Fitness 555 - Stage 1\*





\* Greyed out components not included in stage 1 but can be added at a later stage

Age groups appropriate for:

 Toddlers & Pre-Schoolers

 Primary to Big Kids

 Teenagers to Young Adults

 Whole family / Young at Heart



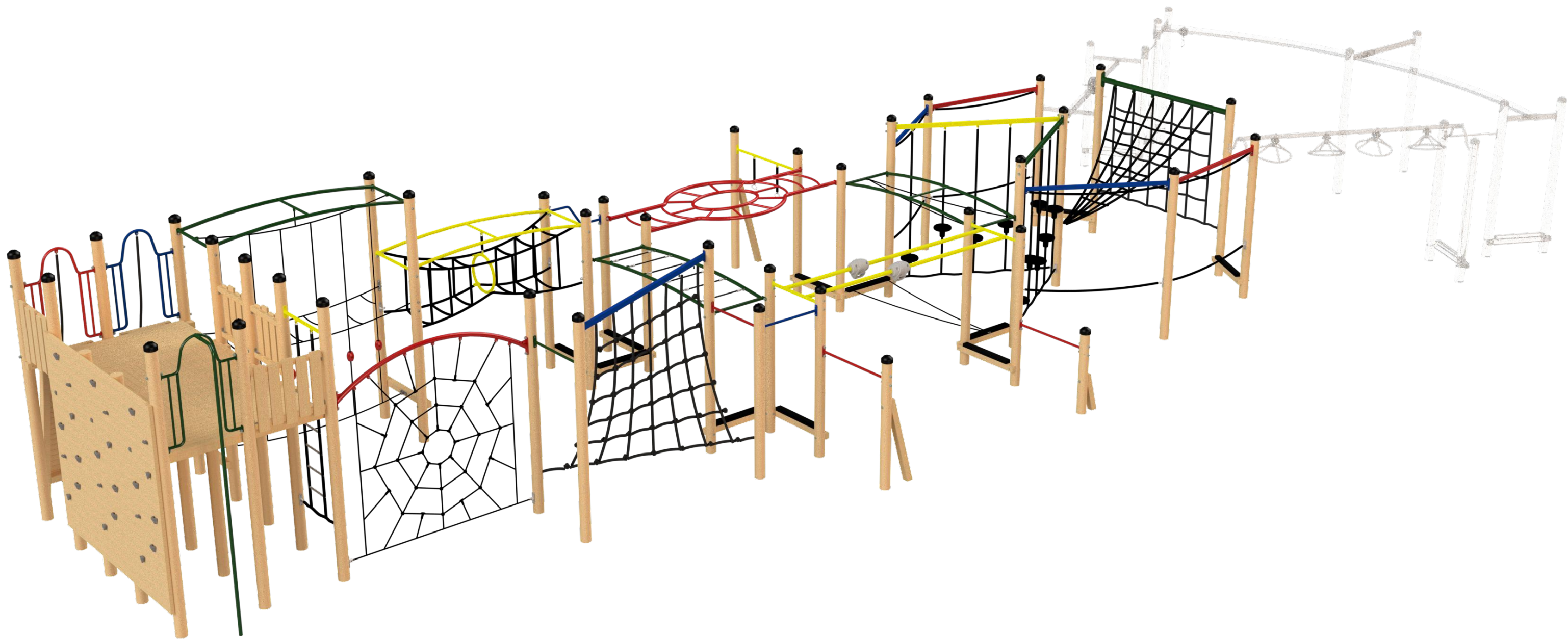

# Xtreme Fitness 555 - Stage 2 (Includes Stage 1)\*





\* Greyed out components not included in stage 2 but can be added at a later stage

Age groups appropriate for:

 Toddlers & Pre-Schoolers

 Primary to Big Kids

 Teenagers to Young Adults

 Whole family / Young at Heart

1:100 @ A3

**Fallzone**

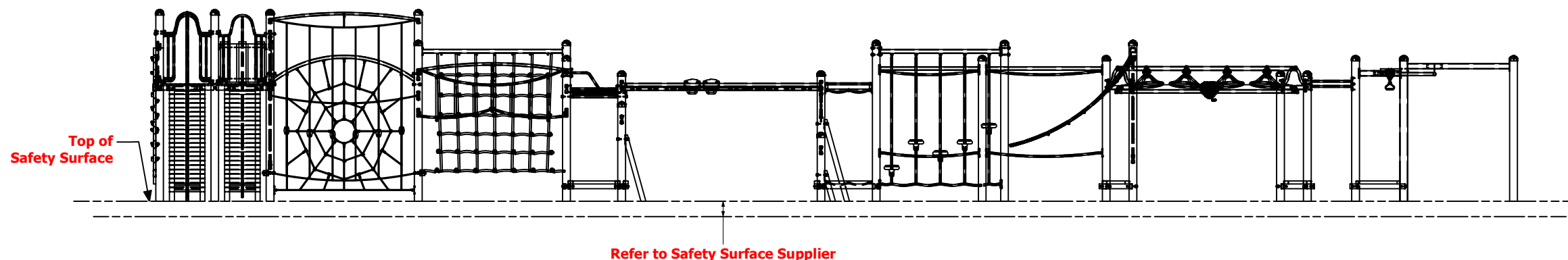
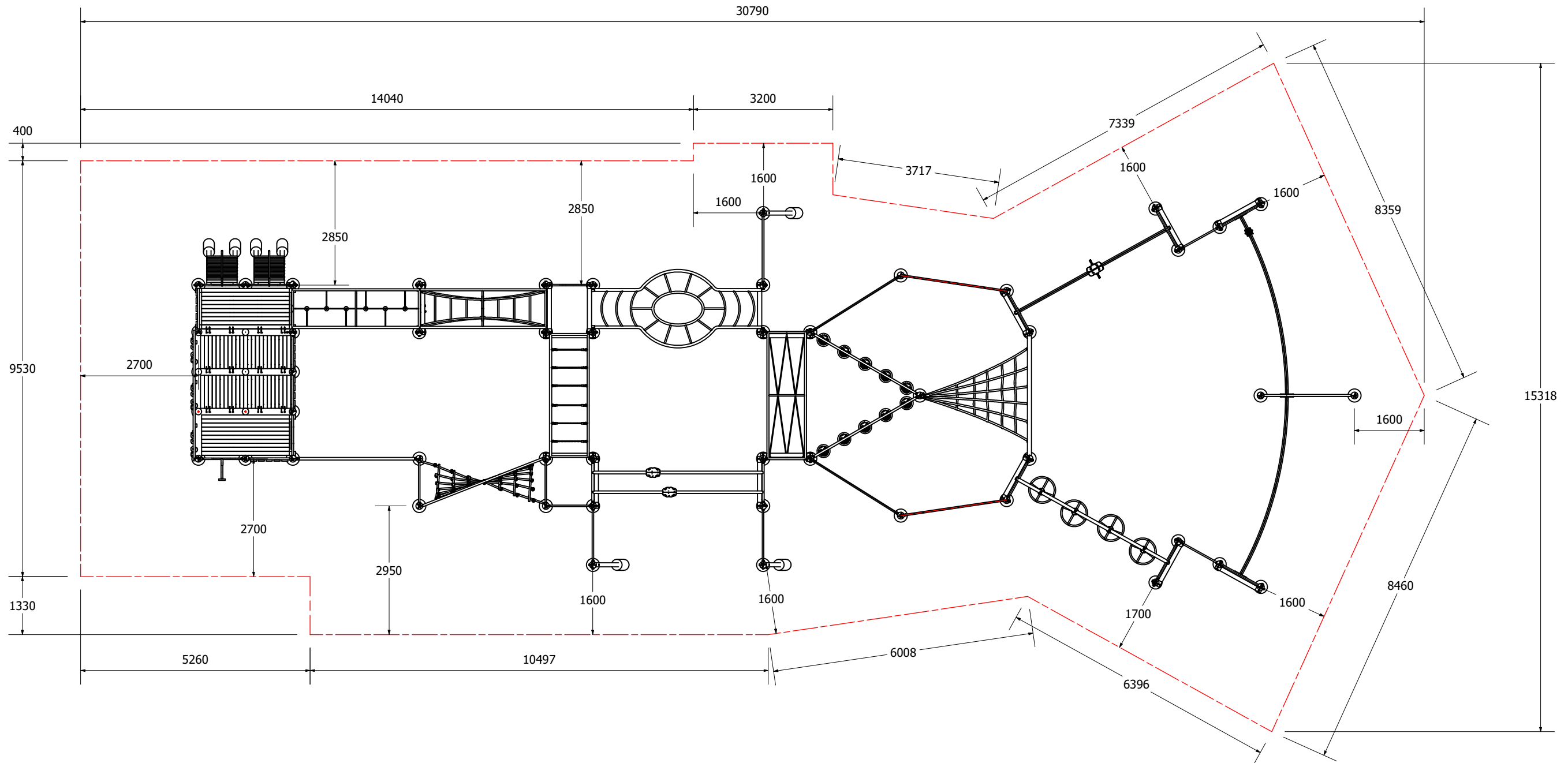





Refer to Safety Surface Supplier

Technical Information	
Main Dimension	30968 x 15238
Total Area	319m <sup>2</sup>
Max FHO	3000
Heaviest Part	--kg
Compliant to	NZS 5828:2015 AS 4685:2017 EN 1176:2008

REVISION HISTORY			
REV	DESCRIPTION	DATE	BY
1	Creation	29/10/2020	Sam
2	Updated stages	17.03.21	FJC

Age groups appropriate for:

-  Toddlers & Pre-Schoolers
-  Primary to Big Kids
-  Teenagers to Young Adults
-  Whole family / Young at Heart



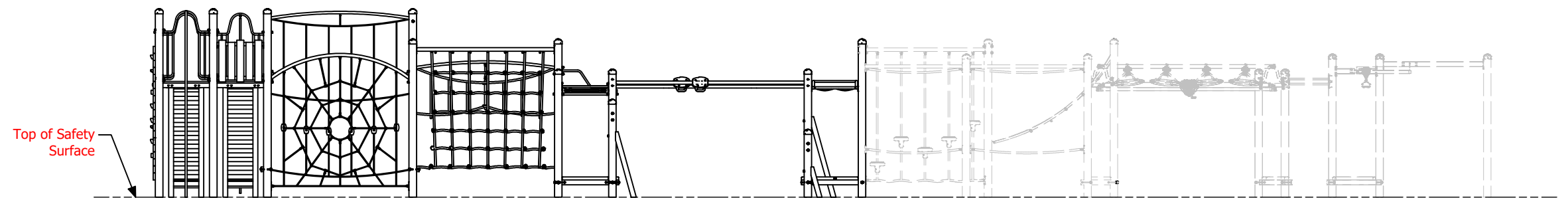
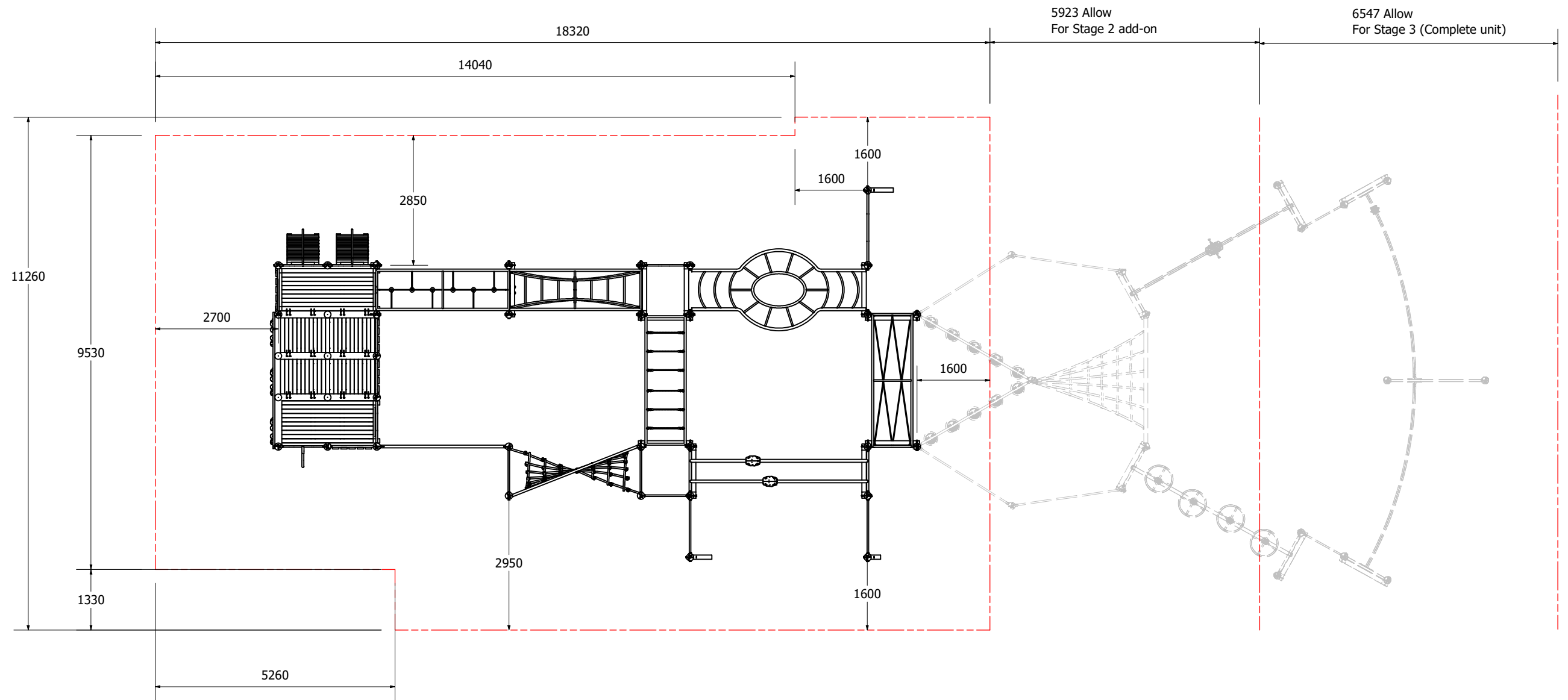

1:100 @ A3

## Fallzone - Stage 1



Technical Information	
Main Dimension	18320 x 11260mm
Total Area	206.2m <sup>2</sup>
Max FHO	3000
Heaviest Part	-
Compliant to	NZS 5828:2015 AS 4685:2017 EN 1176:2008

Age groups appropriate for:

-  Toddlers & Pre-Schoolers
-  Primary to Big Kids
-  Teenagers to Young Adults
-  Whole family / Young at Heart



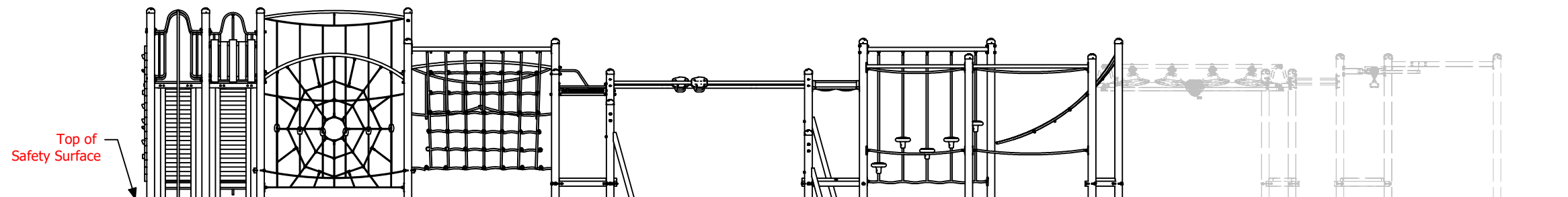
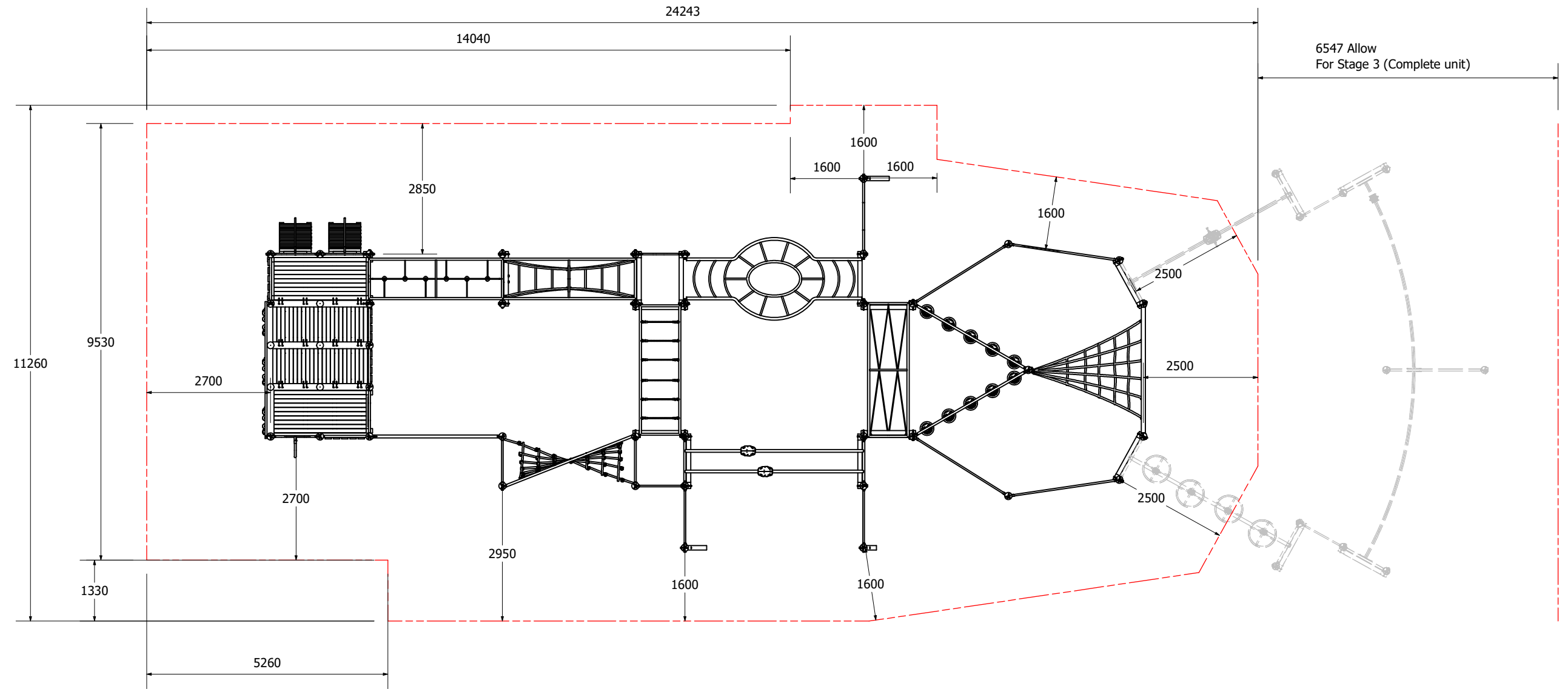

1:100 @ A3

## Fallzone - Stage 2



Technical Information	
Main Dimension	23593 x 11260mm
Total Area	265.6m <sup>2</sup>
Max FHO	3000
Heaviest Part	-
Compliant to	NZS 5828:2015 AS 4685:2017 EN 1176:2008

Age groups appropriate for:

-  Toddlers & Pre-Schoolers
-  Primary to Big Kids
-  Teenagers to Young Adults
-  Whole family / Young at Heart