



Wanaka 107 - Urban

Product Code: MOMP107-U



Age groups appropriate for:

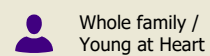
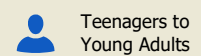
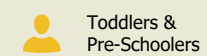

Wanaka 107 - Urban

Product Code: MOMP107-U

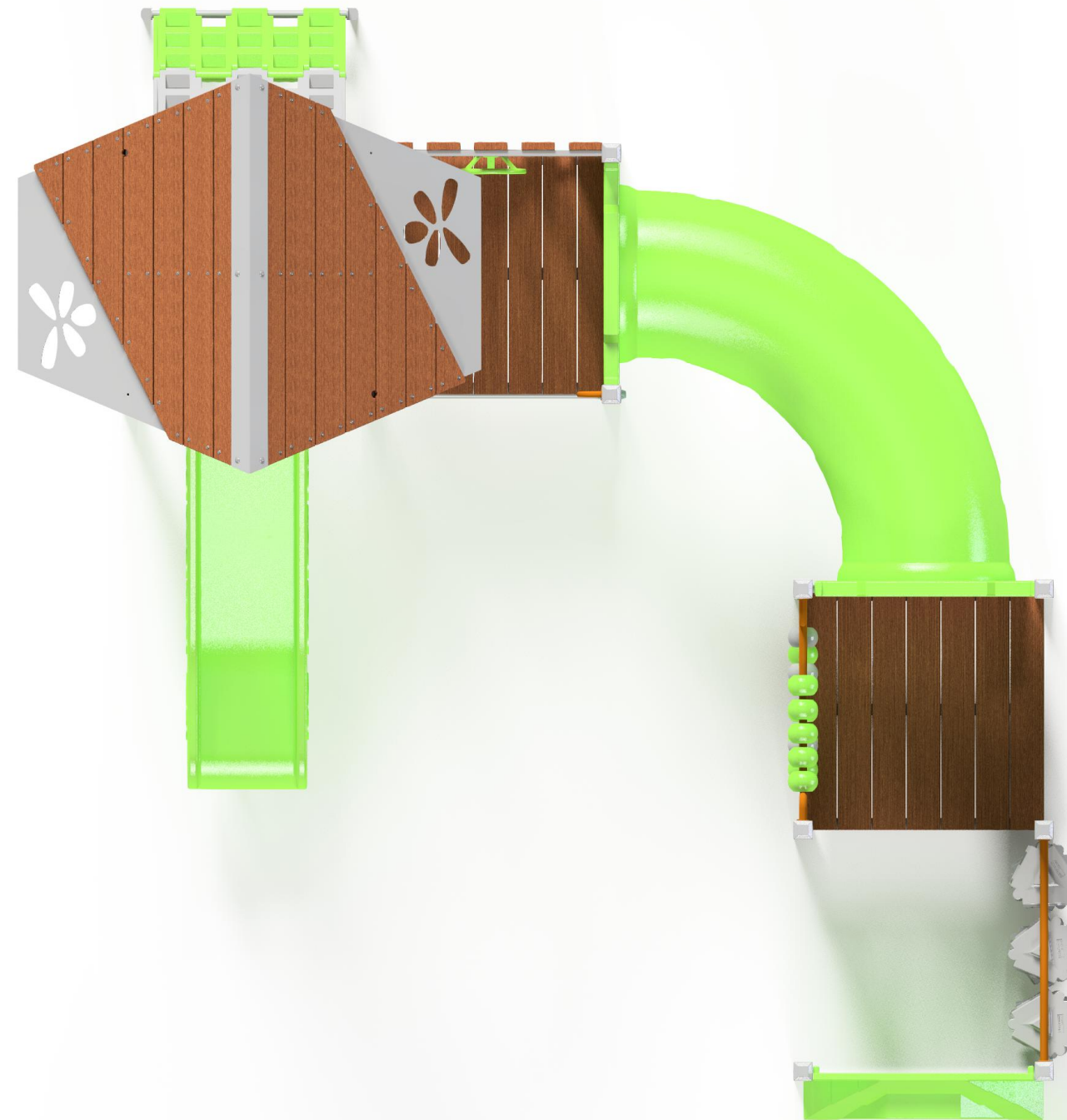

1:100 @ A3

Fallzones

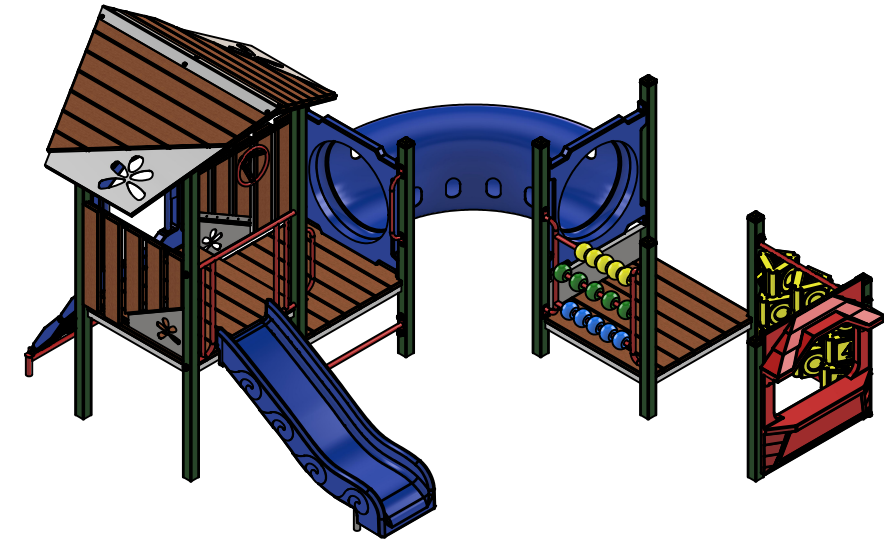
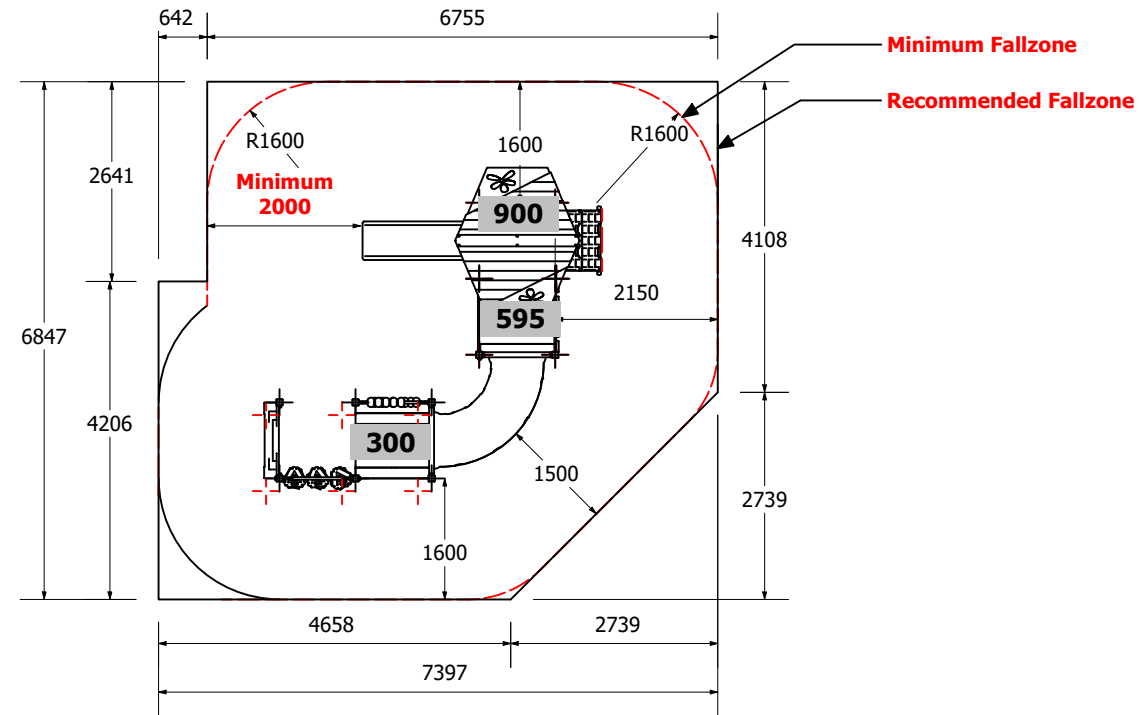

Front Elevation

Right Elevation

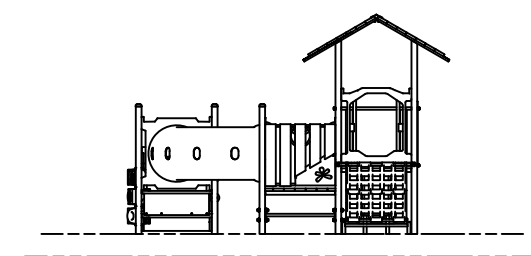
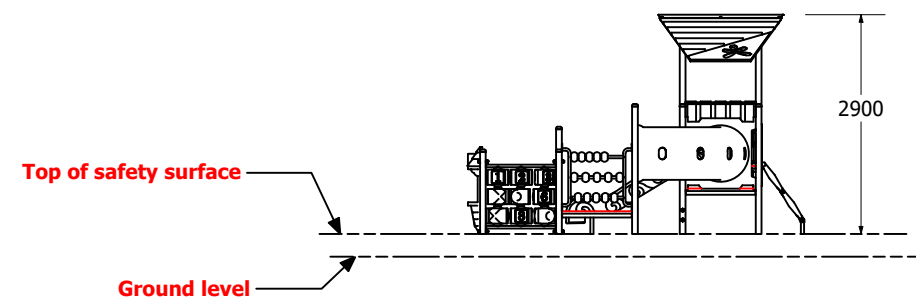

Technical Information	
Main Dimension	7397x6847
Total Area	50.7m ²
Max FHO	900
Heaviest Part	40kg
Compliant to	NZS 5828:2015 AS 4685:(series) EN 1176:2008

Please note: This playground is easily accessible for those under 36 months.

REVISION HISTORY			
REV	DESCRIPTION	DATE	BY
2	Creation	29/05/2020	Sam
3	Changed Crawl Tunnel Dims	13/6/2022	HS

Age groups appropriate for:

