

# Xtreme Elite 606 - MP - Stage 3 (Complete Unit)

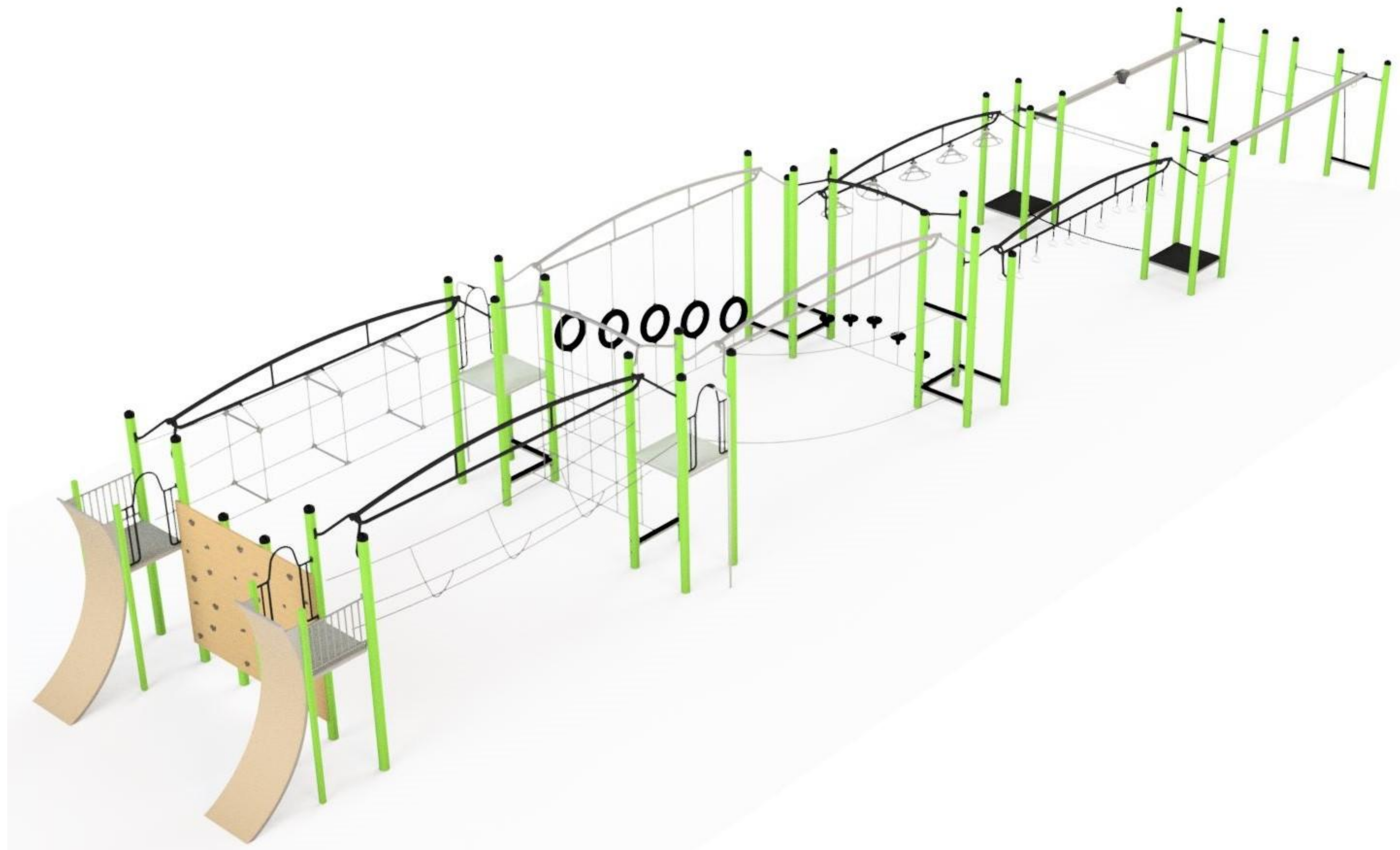

# Xtreme Elite 606 - MP - Stage 3 (Complete Unit)

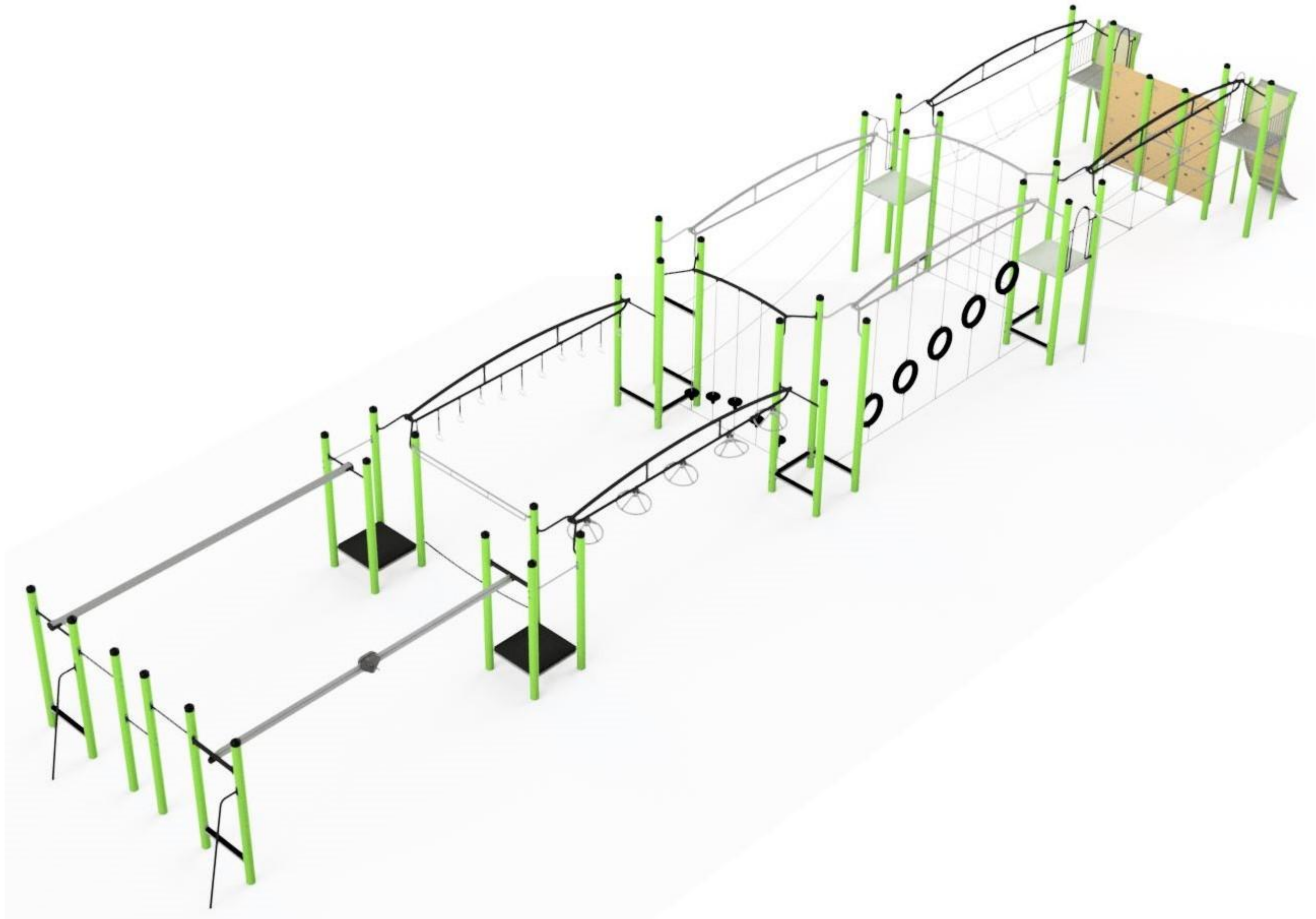

# Xtreme Elite 606 - MP - Stage 3 (Complete Unit)

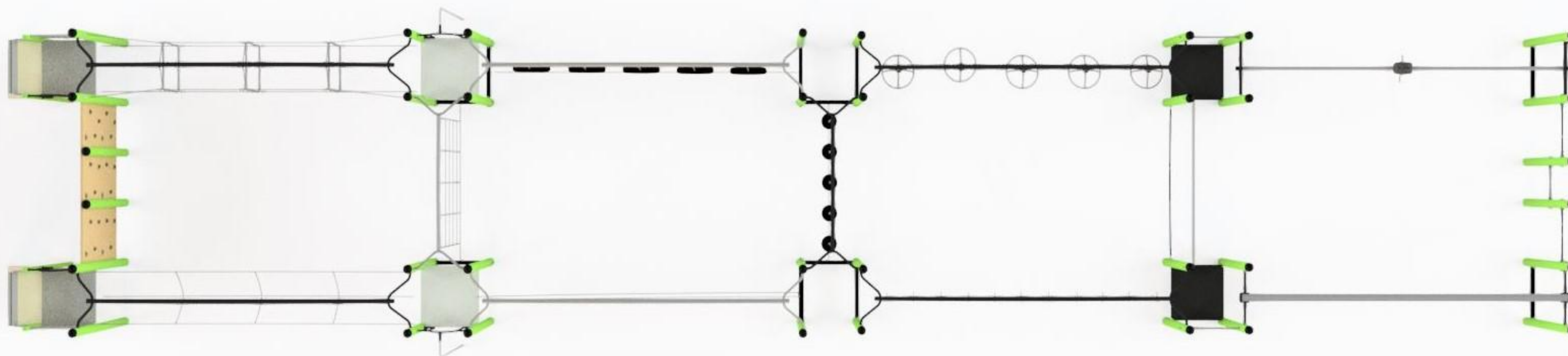

# Xtreme Elite 606 - MP - Stage 1\*

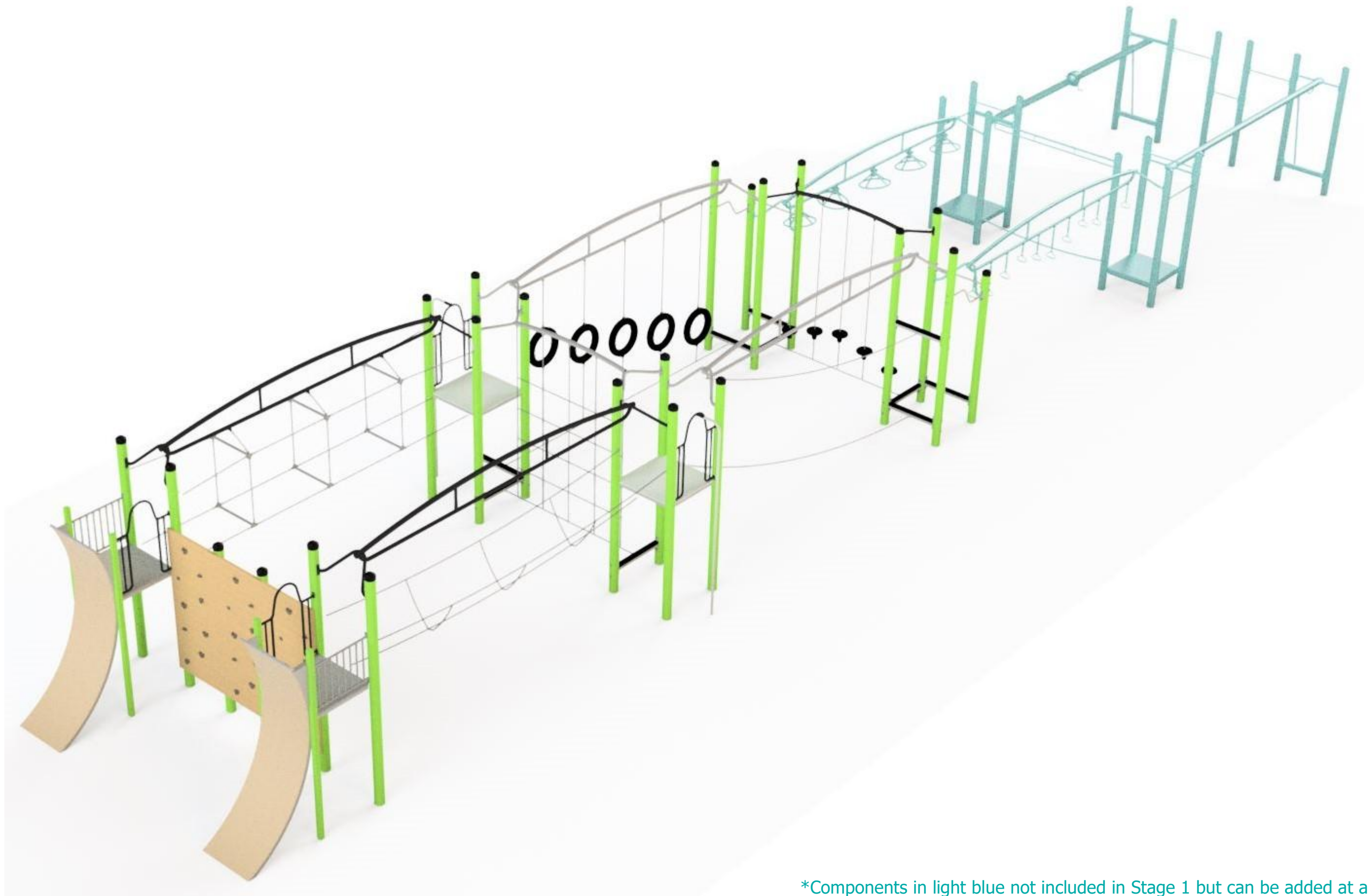



\*Components in light blue not included in Stage 1 but can be added at a later stage

Age groups appropriate for:

 Toddlers & Pre-Schoolers

 Primary to Big Kids

 Teenagers to Young Adults

 Whole family / Young at Heart

# Xtreme Elite 606 - MP - Stage 2 (Includes Stage 1)\*

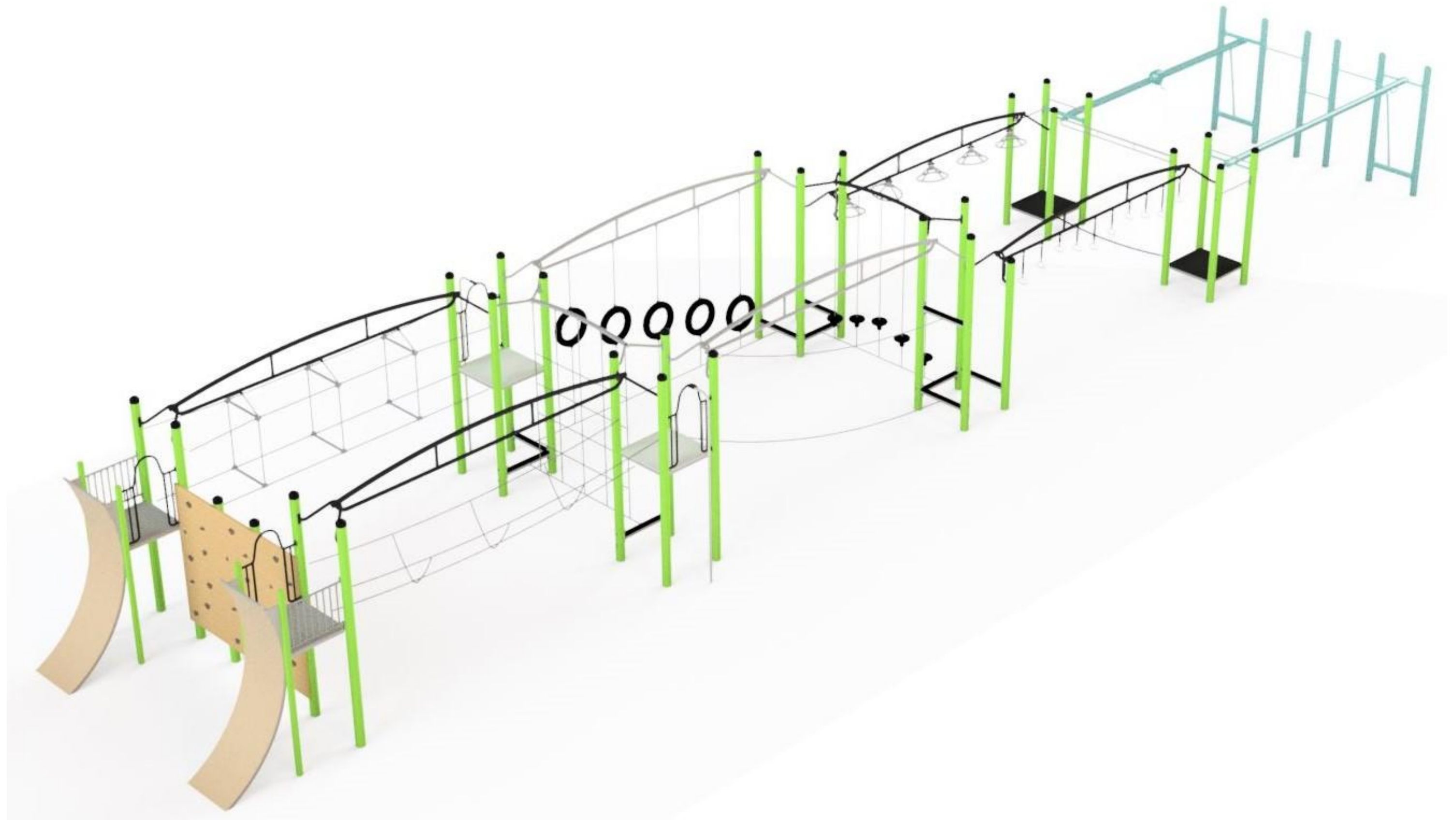



\*Components in light blue not included in Stage 2 but can be added at a later stage

Age groups appropriate for:

 Toddlers & Pre-Schoolers

 Primary to Big Kids

 Teenagers to Young Adults

 Whole family / Young at Heart

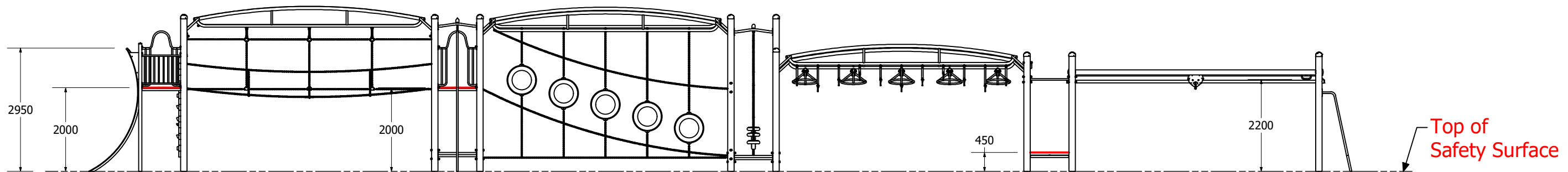
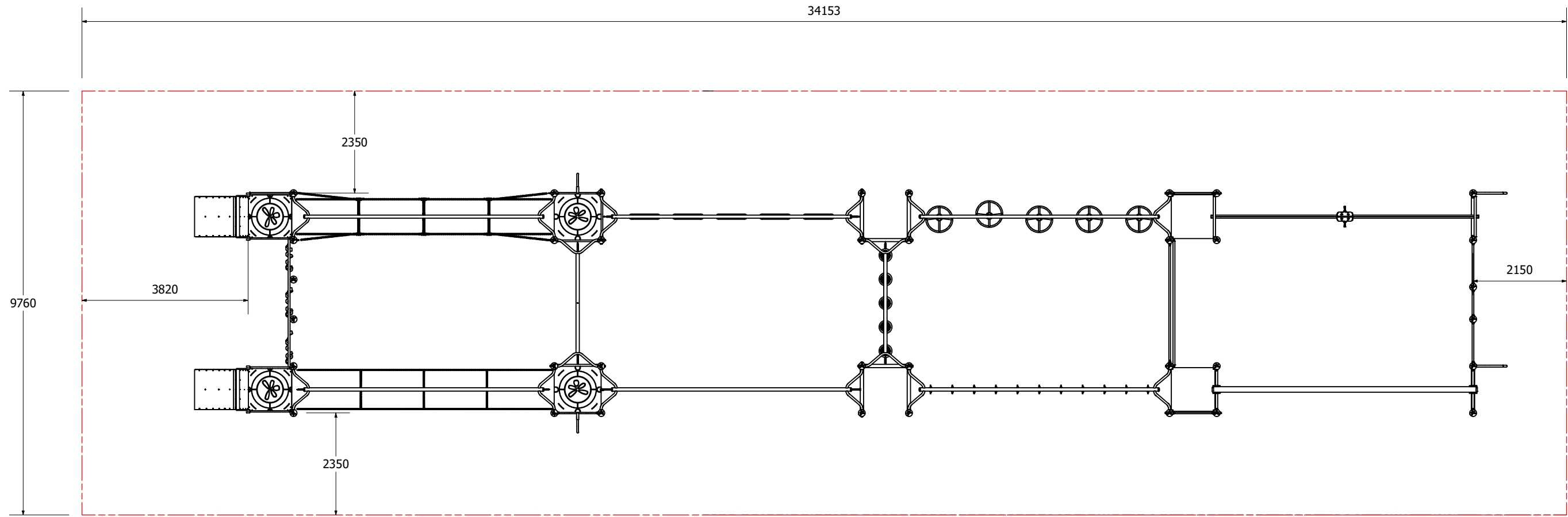

Technical Information	
Main Dimension	34153 x 9760mm
Total Area	333.3m <sup>2</sup>
Max FHO	3000
Heaviest Part	-
Compliant to	NZS 5828:2015 AS 4685:2017 EN 1176:2008

REVISION HISTORY			
REV	DESCRIPTION	DATE	BY
0	Creation	19/11/2020	Sam
1	Updated Stages	17.03.2021	FJC

# Xtreme Elite 606 - MP - Stage 1

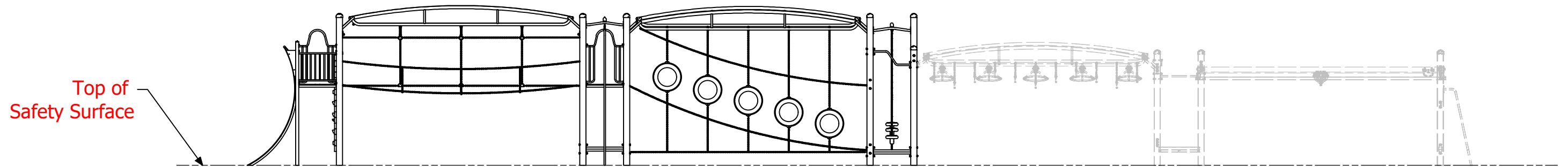
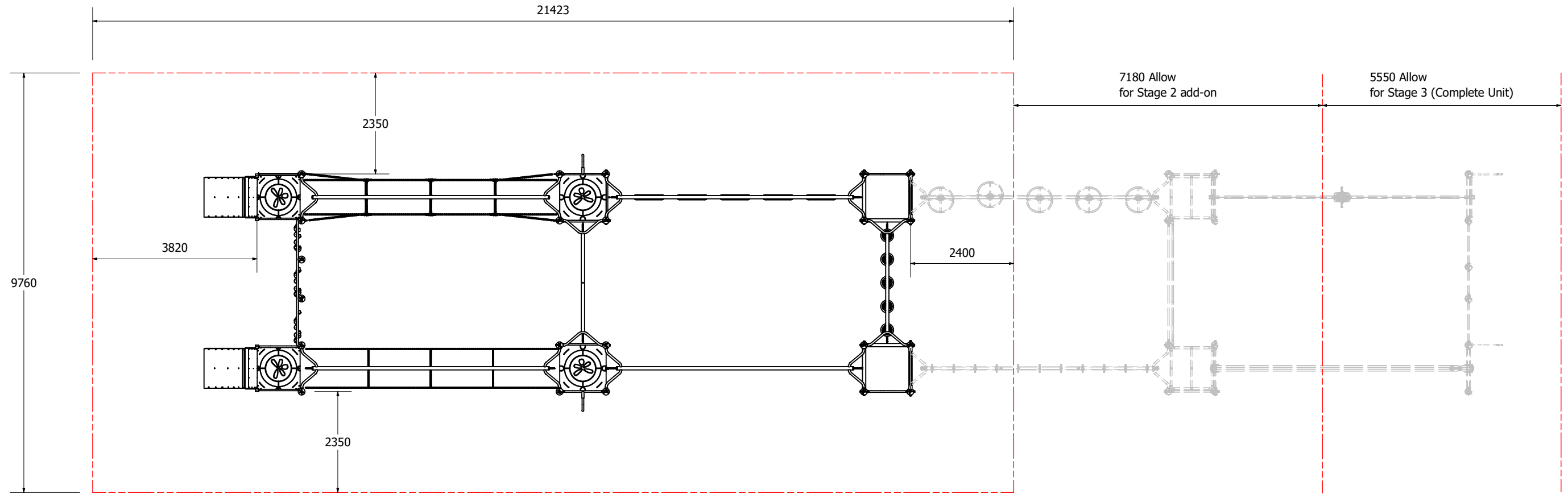

Technical Information	
Main Dimension	21423 x 9760mm
Total Area	209m2
Max FHO	3000
Heaviest Part	-
Compliant to	NZS 5828:2015 AS 4685:2017 EN 1176:2008

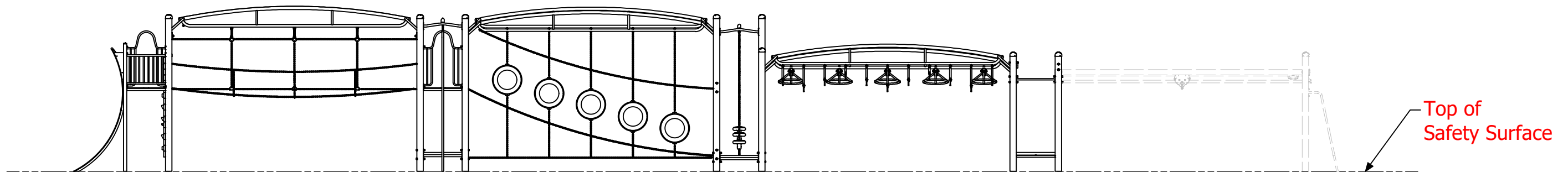
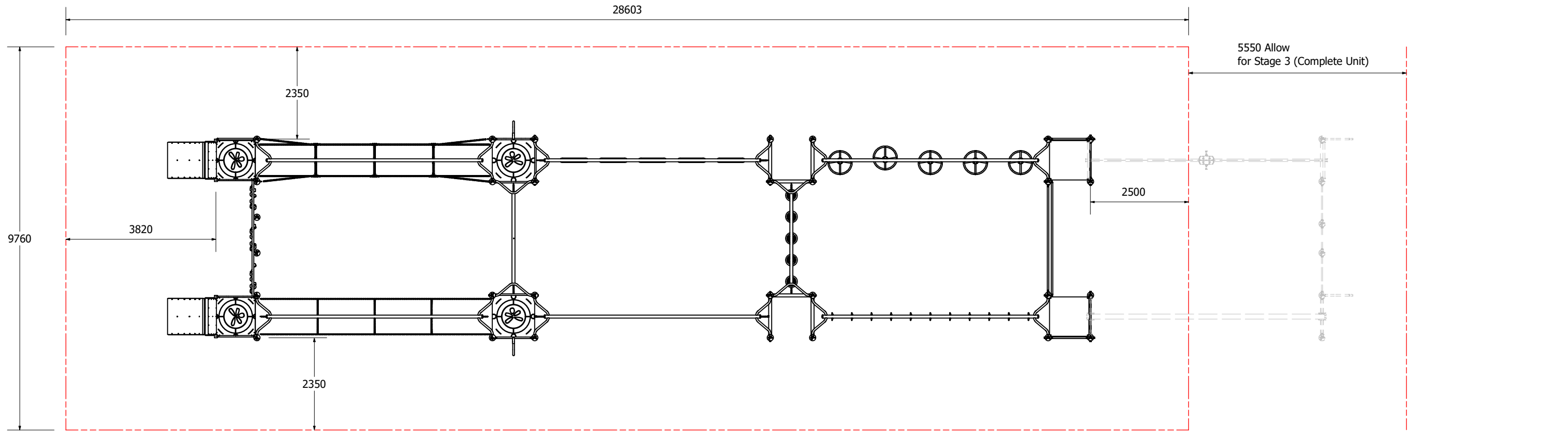

Technical Information	
Main Dimension	28603 x 9760mm
Total Area	279.1m <sup>2</sup>
Max FHO	3000
Heaviest Part	-
Compliant to	NZS 5828:2015 AS 4685:2017 EN 1176:2008